

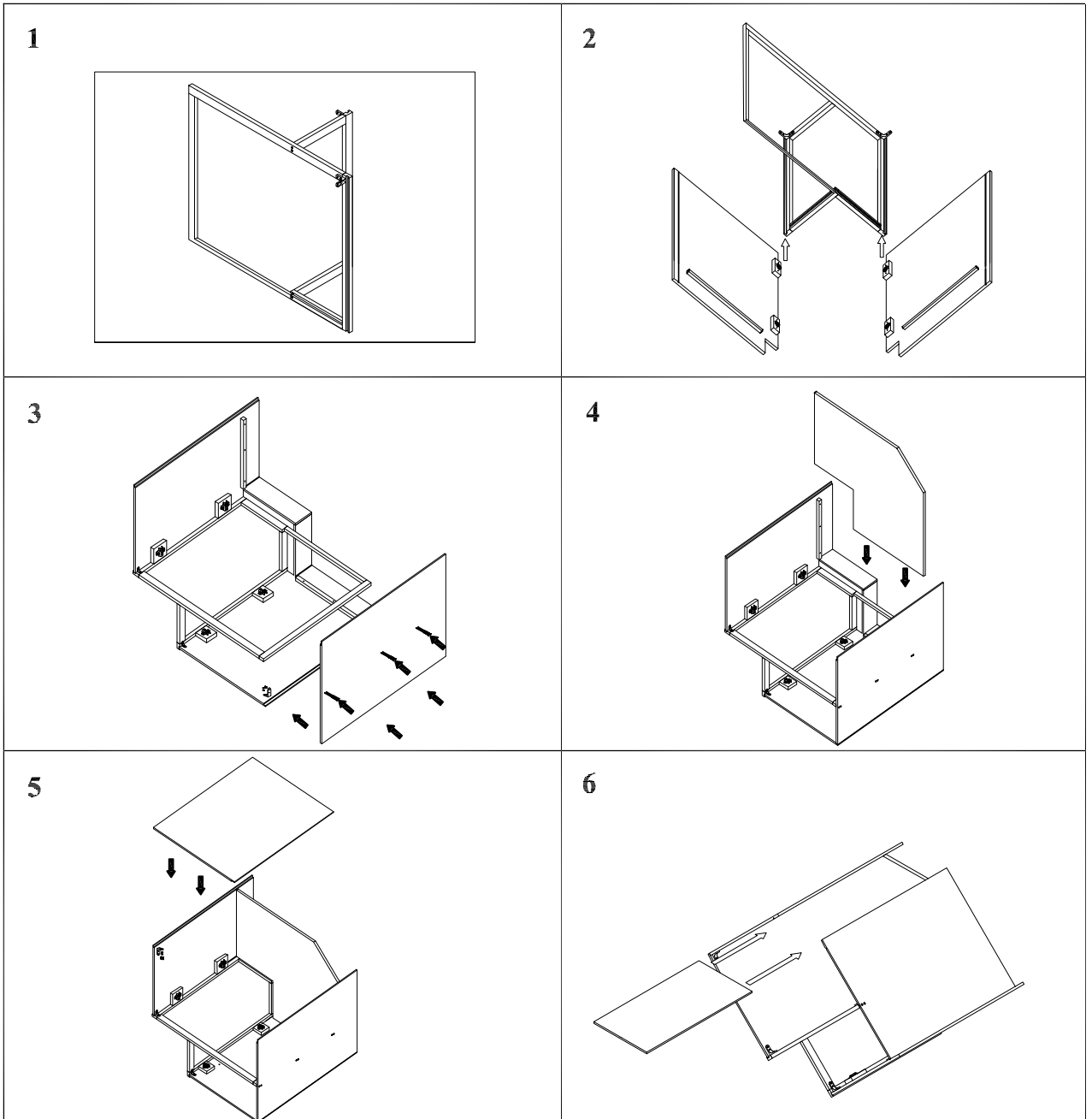

BER Assembly Instructions

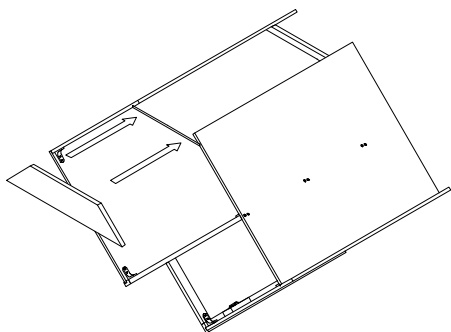

7



8

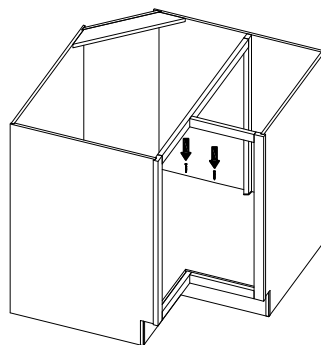

9

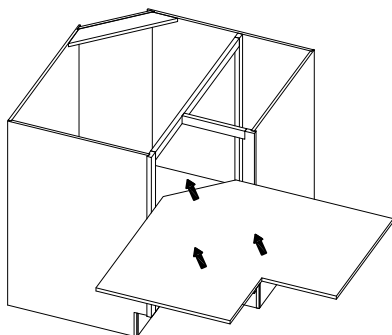

10

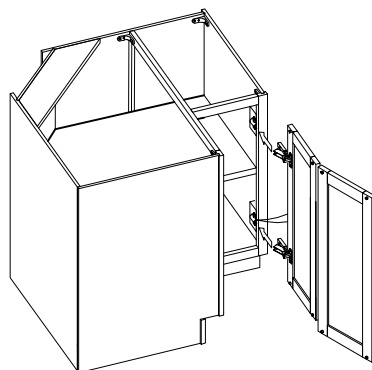

Hinge installation and adjustment

11

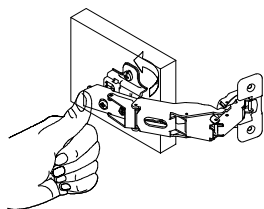

Click and lock

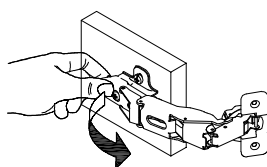

Click and remove

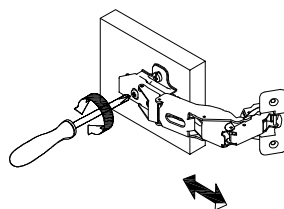

Depth adjustment

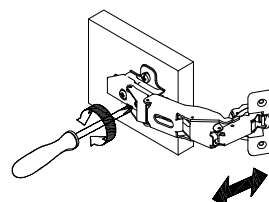

Side adjustment

12

